

EBB-1300S UCHWYT ELEKTROZAMKA DO MONTAŻU NAWIERZCHNIOWEGO

Kod produktu: **EBB-1300S**

do montażu elektrozamka EB-1300R



OPIS

Uchwyt umożliwiający montaż elektrozamka trzpienowego EB-1300R w sposób nawierzchniowy.

Wymiary

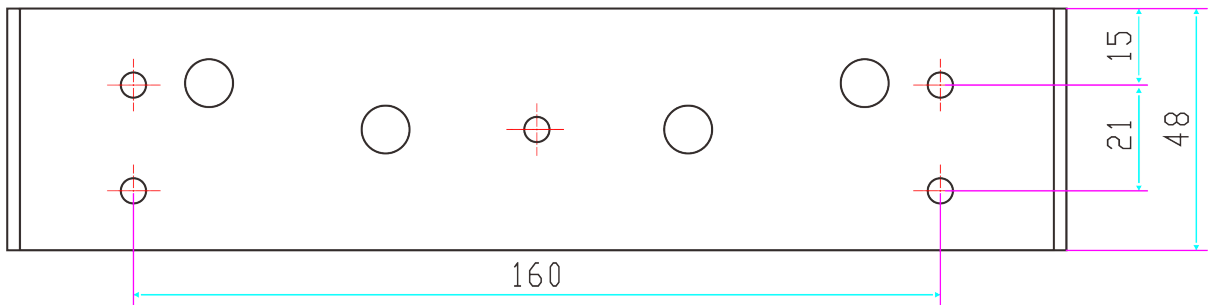
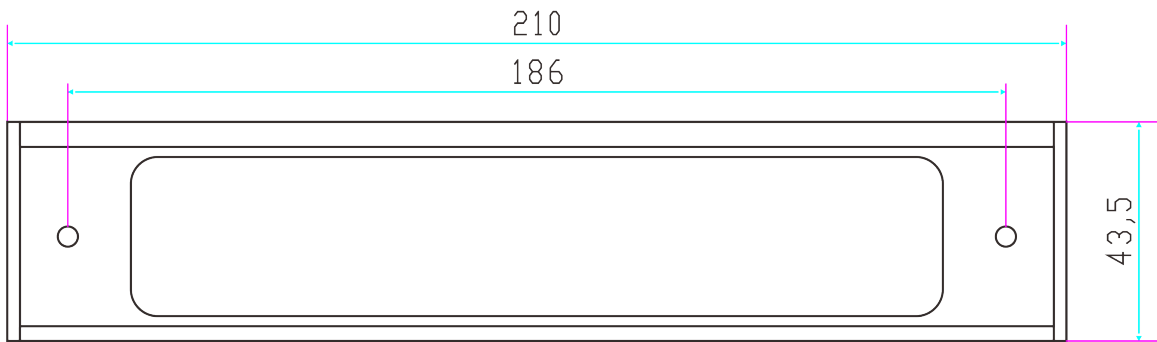
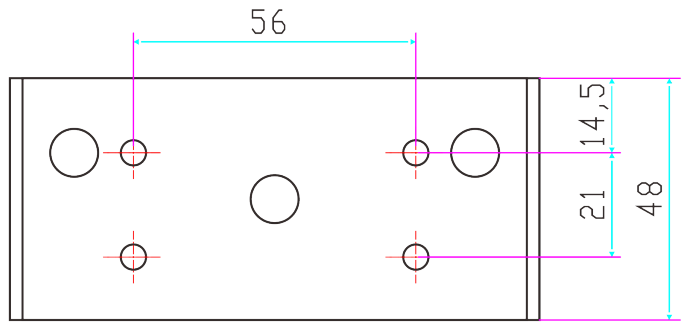
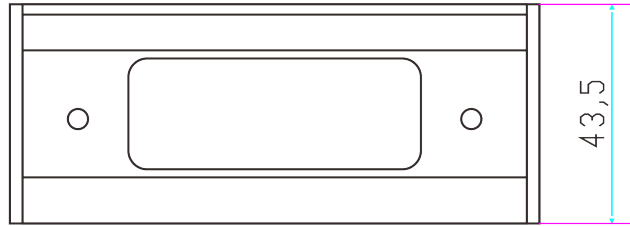
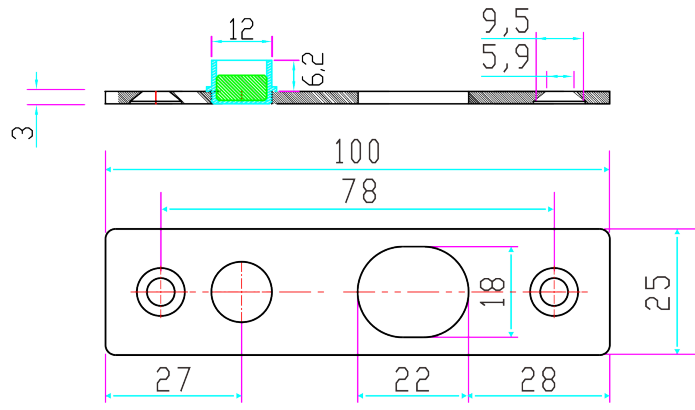
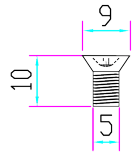
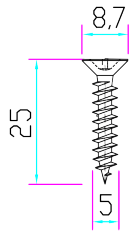

Montáž

